

COMPONENTS 2

INSTALLATION

Step 1 – Review 3

Step 2 – Preparation 3

Step 3 – Metal Inlet 3

Step 4 – Assemble Suspension 3

Step 5 – Cable 3

Step 6 – Fabric 5

Step 7 – Supports 5

Step 8 – Cable Stops 5

OVERVIEW

Thank you for selecting a SimpleSox™ System. This guide should be helpful for installing SimpleSox™. Sections of fabric will be labeled, assembled, bagged, and boxed for shipping.

Inventory

The first step on any installation project is to check the order and familiarize yourself with what needs to be installed. We suggest reading through this manual completely to properly educate yourself on field installation. Please make sure you have all the required components for the SimpleSox™ System.

READ INSTRUCTIONS THOROUGHLY BEFORE BEGINNING.

Equipment Required:

- Drill
- Screwdriver
- Tape measure
- Marker or pencil
- 5/16 nut driver
- Ladder or lift for extended heights

Available Components/Details

Cable Assembly Kit:
Includes 2 Gripple® Turnbuckles, 2 eyebolts and nuts, 6 cable clamps, 120' of 1/8" galvanized cable.

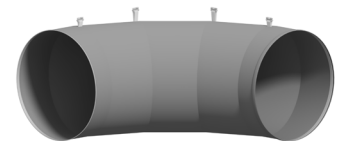
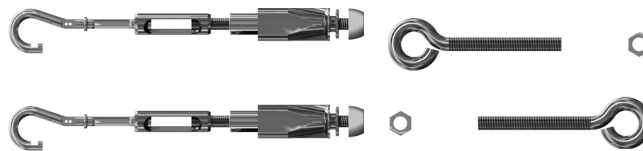

90 Degree Elbow



1' Inlet



3" Endcap



Adjustable Flow Device
(Fabric Mesh Damper)

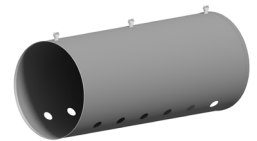

4' Active Section

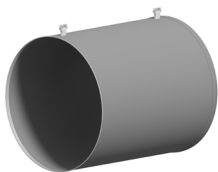

2' Inactive Section

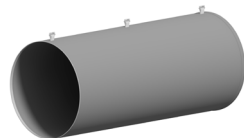

4' Inactive Section

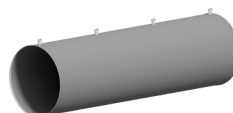

6' Inactive Section

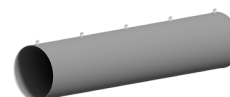

8' Inactive Section

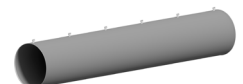

10' Inactive Section

INSTALLATION STEPS

1. Review materials to confirm all parts fit the pre-determined design.
2. Assess product placement area to confirm the system will fit in the required space.
3. Prepare metal inlet collar for fabric connection.
4. Locate cable anchors and components.
5. Install cable end supports.
6. Install the fabric.
7. Use excess cable and cable clamps for mid-supports.
8. Install cable stops.

Step 1

REVIEW MATERIALS TO CONFIRM ALL PARTS FIT THE PRE-DETERMINED DESIGN. READ INSTRUCTIONS THOROUGHLY BEFORE BEGINNING.

Step 2

Assess product placement area to confirm the system will fit in the required space.

Step 3

Prepare metal inlet collar for fabric connection.

- Confirm inlet air supply location and size.
- SimpleSox™ inlets are manufactured 1/2" larger than specified to fit over metal inlet collar.
- Metal collar length should be 6"-10" to secure fabric inlet.
- Edge guard (provided) should be installed on the edge of the metal collar to reduce fabric wear on metal edge.

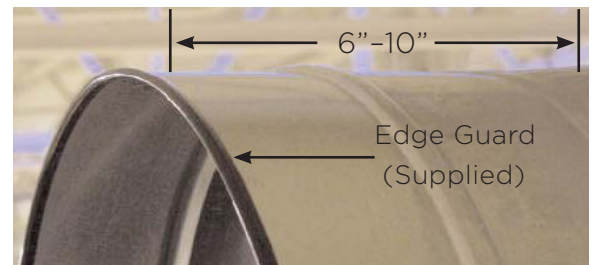

Step 4

Locate cable anchors/components. Tension

cable system includes 1/8" cable and hardware as shown. Hardware kit includes: 2 Gripple® turnbuckles, 2 eyebolts and nuts, 6 cable clamps, galvanized cable length 120'.



Step 5

Install cable end supports as required (by others with example shown below). Hang cable 1.5" above top of system.

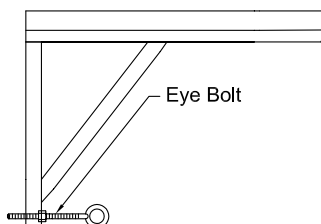

Suggested SimpleSox™ Ceiling Gusset Brace:
1" x 1" angle iron or slotted channel to
attached DuctSox cable hanging system

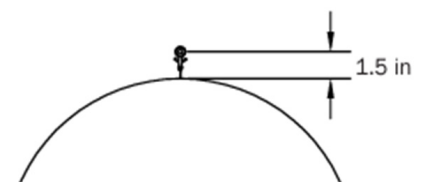

The following details will walk you through how to install the Gripple® turnbuckles properly.

a. Eyebolts must be fastened to the structure of the building (including knee braces) by others. The cable must be mounted 1.5 in (38 mm) above the 12:00 location of the SimpleSox™.



b. Hook Gripple® Turnbuckles to the installed eyebolts.



c. Insert cable into the plastic end of the Gripple® Turnbuckle and push/pull it through the opening on the side of the Gripple® Turnbuckle.

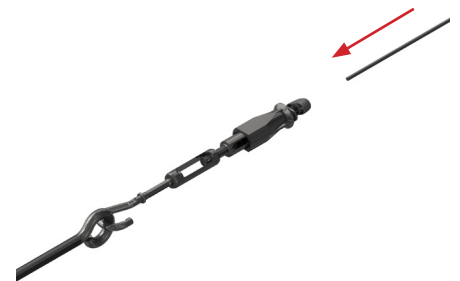

Note: To release the cable hold in the plastic button and slide the turnbuckle. To lock the button twist the plastic until tight.



d. Tighten the cable to 100 lb (445 Newtons) tension by pulling the cable tight and then twisting the turnbuckles. Clip extra cable when finished, leaving about 3 in (76 mm) of cable extending through the side the Gripple Turnbuckle.

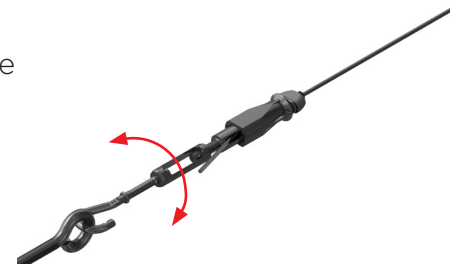

Step 6

Install the fabric.



If your SimpleSox™ System has elbows: Install cable as shown at right 1.5" above top of the System.

NOTE: The elbows are meant to be interchangeable left or right when connected to the SimpleSox™ System. The double zipper allows for this.

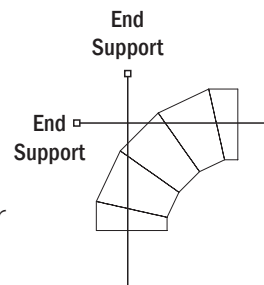

Sample System

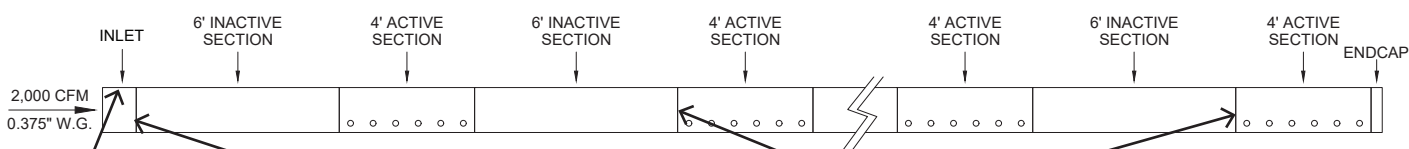

1 Secure attachments to suspension system (inlet section first if not zipped together).

2 Slide SimpleSox™ inlet over collar and position the zipper start/stop at top center and tighten the DuctBelt.

Secure anchors with standard screws (not provided) after start-up (to ensure proper inflated alignment).

3 Clip SimpleSox™ System onto cable. Connect sections together with zippers. The pull (female end) of the zipper is located towards the end away from the inlet of the section.

Step 7

To prevent “sagging,” use excess cable and cable clamps for mid-supports every 30 feet maximum.

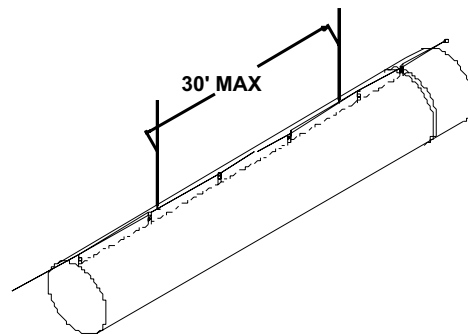

Step 8

Install cable stops. Once system is properly adjusted, deflate the system, pull the last snap in each straight section, and secure tension using cable clamp to cable (will reduce inflation “popping”). If the system includes elbows, secure the last snap before elbow(s).

Cable clamps are provided to secure snaps.

Failure to install the SimpleSox™ System correctly can void warranty.

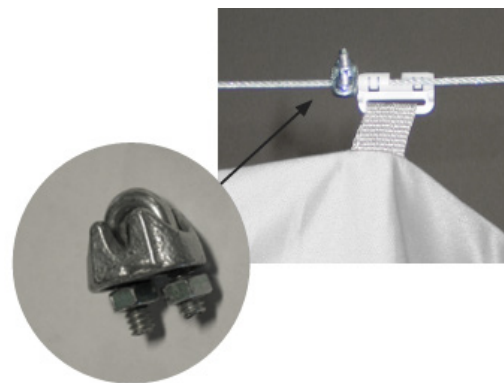

Laundering Instructions

- Remove system and break down into sections
- Turn soiled side out, soak in cold water for 30 minutes
- Wash cold, gentle cycle
- Rinse thoroughly (repeat cycle if water/SimpleSox still soiled)
- Drip dry or no heat tumble dry



If any questions arise regarding the installation of your SimpleSox System, contact us.

866-382-8769 or 563-588-5300

DuctSox Corporation
4343 Chavenelle Rd
Dubuque, IA 52002

Phone: 563-588-5300
Toll-free: 866-382-8769
Fax: 563-588-5330

ductsox.com

DUCTSOX[®]
Redefining Air Dispersion