

Thank you for selecting a DuctSox System. This manual will be helpful for the installation of a Hoops (IHS) Cable System. Sections of fabric will be labeled, assembled, bagged, and boxed for shipping. More complicated systems will include a CAD detail of the system identifying what is in each package. NOTE: The DuctSox cable attachment (Glider) is built for 1/8 in (3 mm) cable only.

## Overview

### Inventory

The first step on any installation project is to read through this Manual thoroughly and review the components that need to be installed. The best way to do this is to review the drawings of the project while reading the Manual, including the CAD detail if applicable.

### Shipping/Receiving

In some cases the DuctSox support system is delivered to the job site ahead of the DuctSox fabric sections. Depending on the size of a project or order, a DuctSox system will be shipped by common courier in a single brown box or several boxes. Larger orders will be shipped in crates by a common freight courier. Each DuctSox length should be packaged into individual plastic bags and labeled according to size and number of pieces. Other markings or labeling may also be incorporated for larger or more complicated systems. Be sure you have determined all boxes are accounted for.

### Unpacking

Inspect shipment carefully and make sure all pieces are accounted for. Account for everything by emptying the box and examining all contents. Note any missing or damaged pieces listed on the Bill of Lading.

### Labeling

Each DuctSox section will be marked with the size and section number either inside the belt of the inlet or on a tag inside the DuctSox near the zipper. The marking shall be the diameter, section length and total length. If custom labeling has been used, locate an identification sheet that will be included with the delivery.

### Equipment Required:

- Drill
- Level
- Tape measure
- Marker or pencil
- Wrenches for cable clamps and eye bolts (5/16 in and 9/16 in)
- Flat (standard) screwdriver
- Cable cutter

# Component Details

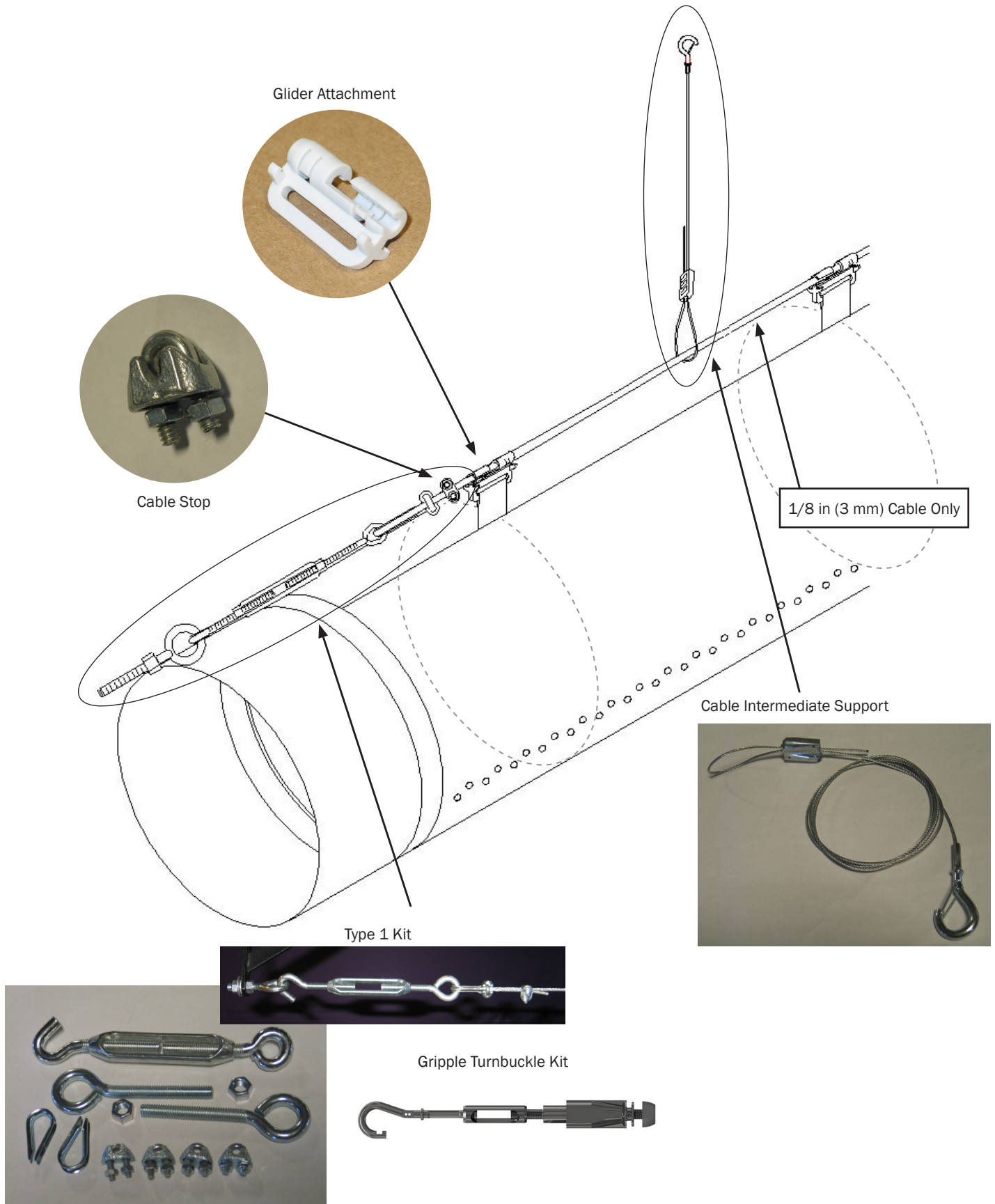

## Installation Steps

1. Review materials in box, including the CAD drawing and installed location of the DuctSox.
2. Prepare metal inlet collar for fabric connection.
3. Mark placement and install cable.
4. Install and assemble DuctSox components.
5. Start up AHU.
6. Balance airflow.

### Step 1

**Review materials in box, including the CAD drawing and installed location of the DuctSox.** READ INSTRUCTIONS THOROUGHLY BEFORE BEGINNING.

### Step 2

#### Prepare metal inlet collar for fabric connection.

- Confirm inlet air supply location.
- Confirm inlet air supply size.
- DuctSox inlets are manufactured 1/2 in (12 mm) larger than specified to fit over metal inlet collar.
- Metal collar length should be 6 in–10 in (150 cm to 250 cm) for secure fabric attachment.
- Edge Guard (provided) should be installed on the edge of the metal collar to reduce fabric wear from the metal edge.

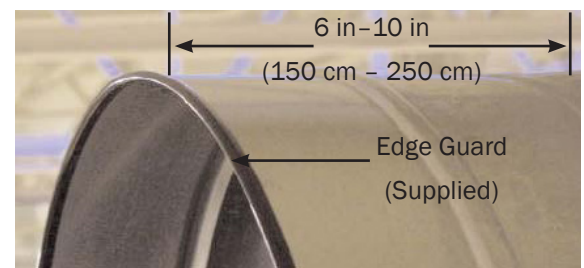

### Step 3

#### Mark Placement and Install Cable.

Step 3 – 1 Row Style

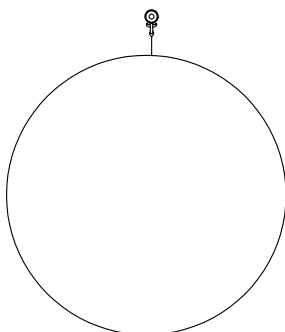

**The following details are used for Galvanized Cable styles.**

1. Eyebolts must be fastened to the structure of the building (including knee braces) by others. They must be fastened in correct locations according to suspension style (Shown in each suspension style's section).



2. Hook Gripple® Turnbuckles to the installed eyebolts.



3. Insert cable into the plastic end of the Gripple® Turnbuckle and push/pull it through the opening on the side of the Gripple® Turnbuckle.

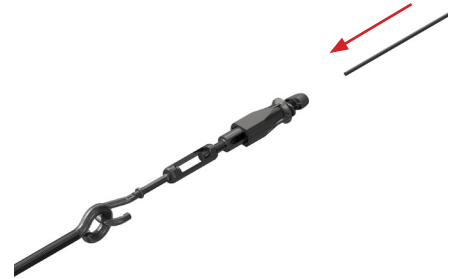

Note: To release the cable hold in the plastic button and slide the turnbuckle. To lock the button twist the plastic until tight.

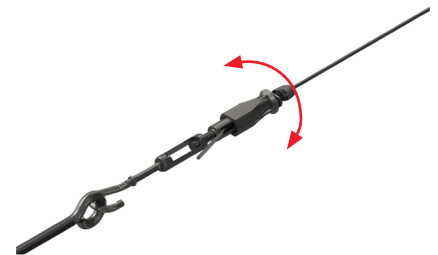

4. Tighten the cable to 100 lb (445 Newtons) tension by pulling the cable tight and then twisting the turnbuckles. Clip extra cable when finished, leaving about 3 in (76 mm) of cable extending through the side the Gripple Turnbuckle.

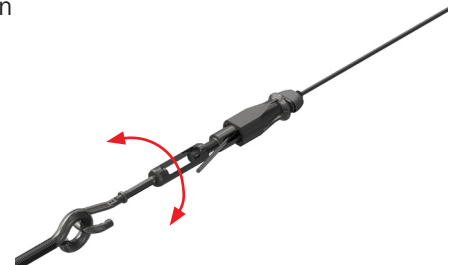

The following details about Type 1 and Type 2 Kits are used for SS and Impregnated Cable styles.

### Type 1 and Type 2 Kits

Type 1 and Type 2 kits are for straight runs of cable:

- Type 1: 50 ft (15250 mm) or less
- Type 2: 50 ft to 100 ft (15250 mm to 30500 mm)
- For systems over 100 ft (30500 mm), a combination of the kits should be used.

These kits include one 6 in (153 mm) turnbuckle (two for Type 2), two eyebolts, two cable thimbles, and four cable clamps.

Eye bolts must be fastened into the structure of the building by others (this could include knee braces).

Cable is fastened directly to an eyebolt with a thimble and two cable clamps. Take the cable end and thread two cable clamps onto it. Now hook the thimble onto the eyebolt. Next, thread the cable onto the thimble and through the eyebolts (cable clamps are still on the cable). Now thread the cable back into the cable clamps and tighten them.

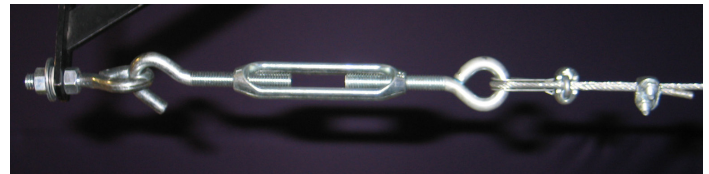
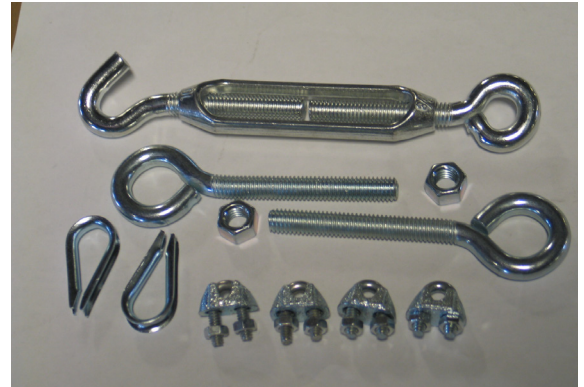

Cable is then fastened directly to the turnbuckle with a thimble and two cable clamps. Slack in the cable is taken up by the turnbuckle. If cable is still too loose after tightening the turnbuckle, loosen the cable, re-fasten cable to turnbuckle at a tighter position, and re-tighten the turnbuckle. Do not over-tighten the turnbuckle, we recommend no more than 100 lbs (445 Newtons) of tensile force.

### Intermediate Support Cable

Installed every 12.5 ft (3810 mm) or less to keep the DuctSox installed at a consistent elevation (reduces sag of the cable).



Galvanized and SS



Impregnated

### Step 3

Determine placement of cable (both cable path and elevation). The cable must be mounted 1.5 in (38 mm) above the 12:00 location of the DuctSox. Intermediate Cable supports are spaced no more than 30 ft (9150 mm).

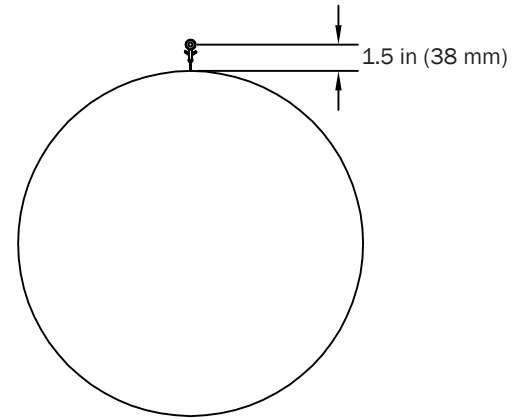

### T's

There should be roughly 12 in (305 mm) from sidewall of DuctSox to the closest edge of any knee-bracing. Structure too close to the main run may cause premature failure due to abrasion from the structure.

NOTE: Offset distance of branch knee-brace from main trunk is approximately half of the main trunk diameter plus 12 in (305 mm).

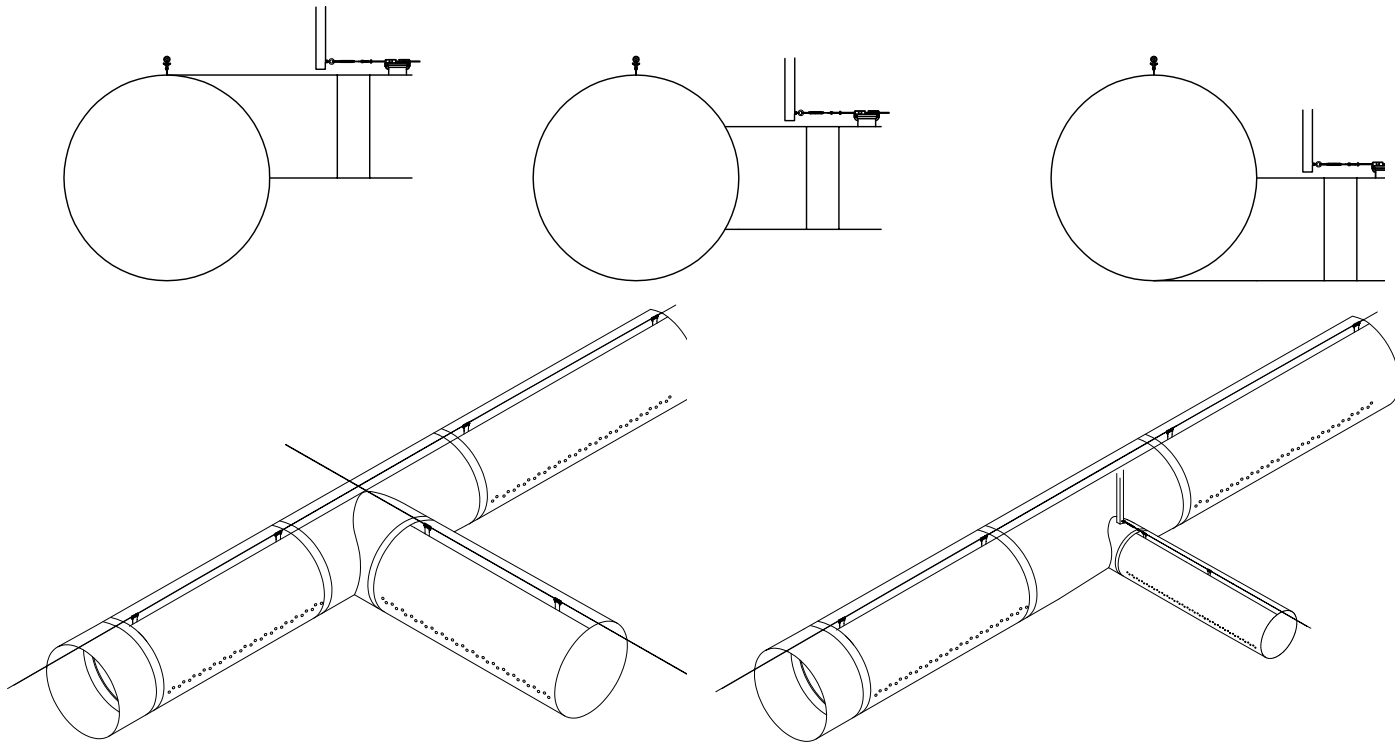

### Elbows

Extended straps on heels of elbows are provided for support to cable suspension (Figure A). Vertical elbows are also supported by extended straps (Figure B).

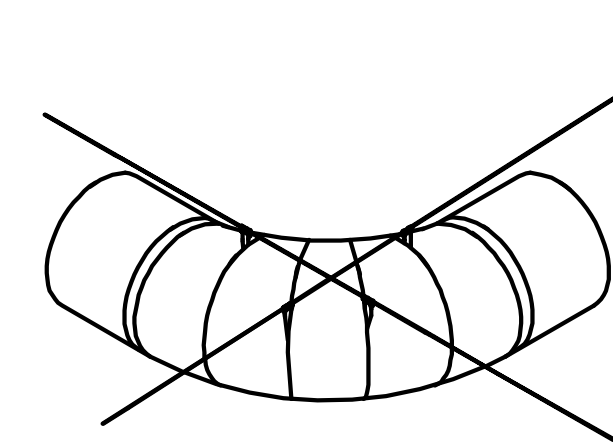

Figure A

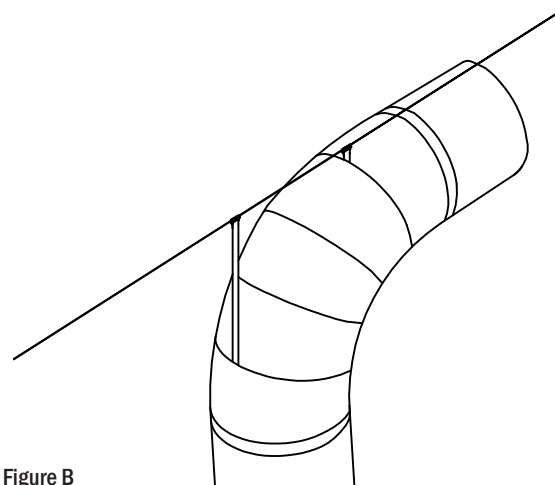

Figure B



## Step 4

**Install DuctSox Fabric.** DuctSox Inlet must be attached to the metal collar using screws (not included) through plastic patches on the Inlet Belt. Be sure to locate the zipper start and seam at the 12:00 orientation for proper alignment.

Twist and snap the Glider attachments of the DuctSox onto the cable (pliers may be helpful for installation and removal of Gliders). Unzip fittings and slide them in place independently of the straight sections. Cable Stops are installed at the Endcap Glider, at the Inlet Glider, and at each Glider immediately adjacent to all fittings. Leave them installed loose until Step 5 is complete. Close all zipper connections before moving to Step 5.

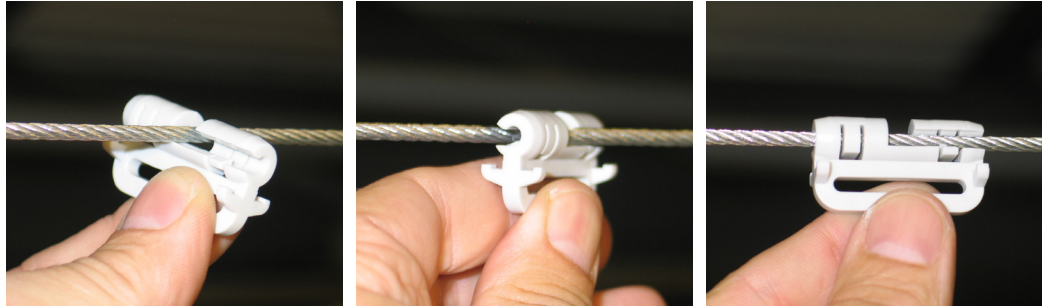

The Cable Stop is used to keep sections of DuctSox from moving lengthwise on the cable. They also are used to put a slight tension on straight sections of DuctSox (straight sections may consist of more than one zippered section of DuctSox). Nuts are tightened to lock the stop at locations where Gliders are to be locked in place (see Step 5).

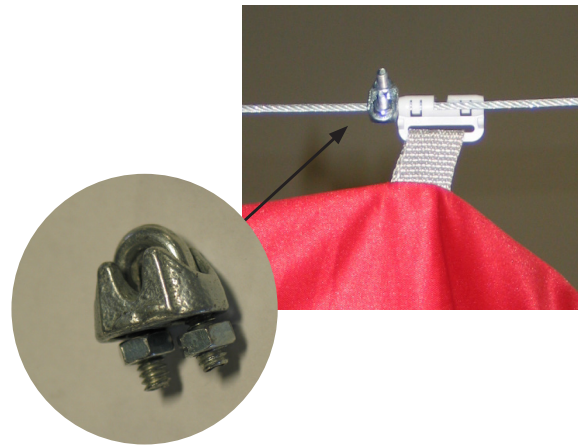

## Step 5

**Start Up AHU.** Turn on the AHU and inflate the DuctSox System. Check all Gliders and sections to ensure system is inflating properly. If required, move Gliders to eliminate puckering at binding locations. If lengths do not fit properly, double check all field measurements and compare to drawings. If all measurements are correct, contact your DuctSox factory rep to discuss options.

Once system is properly adjusted, inflate the system, pull the last Glider in each straight section (including straight sections between fittings), and secure tension using Track Stop Screws. Also, be sure to install a Track Stop Screw into the U-Track at the Endcap Glider, at the Inlet Glider, and at each Glider immediately adjacent to all fittings.

The Track Stop Screw is used to keep sections of DuctSox from moving lengthwise in the U-track. They also are used to put a slight tension on straight sections of DuctSox (straight sections may consist of more than one zippered section of DuctSox). The screw is tightened into the bottom channel to lock the stop at locations where Gliders are to be locked in place.

If the system includes elbows or T's, secure Gliders before and after these fittings. Failure to install DuctSox Systems correctly may void warranty.

## Step 6

**Air Balancing.** System must be balanced to design CFM and static pressure immediately after installation. Most DuctSox Systems include a zipper at the inlet location for easy access to monitor flow.

If the fabric is fluttering after balancing, please contact your factory rep immediately. Solutions to the fluttering include adjusting the Adjustable Flow Device (AFD), adding AFDs, or other solutions that would result in a less turbulent airflow.

### Laundering Instructions

Sedona-Xm, TufTex, Verona, DuraTex, Microbe-X, Rx, and Stat-X fabrics:

- Remove the DuctSox fabric from your system, being sure to unzip all sections. Take care in recording where each section was installed.
- Remove the hoops from the DuctSox system by simply twisting the attachment sideways. *Note: the hoop attachment only slides one way.*
- Turn soiled side out and soak in cold water for 30 minutes.
- Wash cold, gentle cycle.
- Rinse thoroughly (repeat cycle if water/DuctSox still soiled).
- Drip dry or no-heat tumble dry.

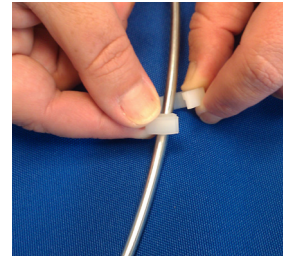









## CUSTOMER SERVICE

### DUCTSOX WORLD HEADQUARTERS

4343 Chavenelle Road  
Dubuque, Iowa 52002

 563-588-5300